

CONFIDENTIAL

This document is the property of Evapco, Inc. It should not be copied or disclosed without prior written authorization.

CUSTOMER	MODEL #	U-SSTWE1-9R43F0100F1LA	SCALE	N.T.S.	DWG. #	USSTW1-SE-4L	REV.	0	DATE	3/4/2025
----------	---------	------------------------	-------	--------	--------	--------------	------	---	------	----------

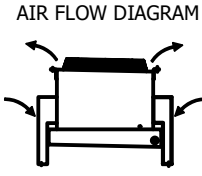
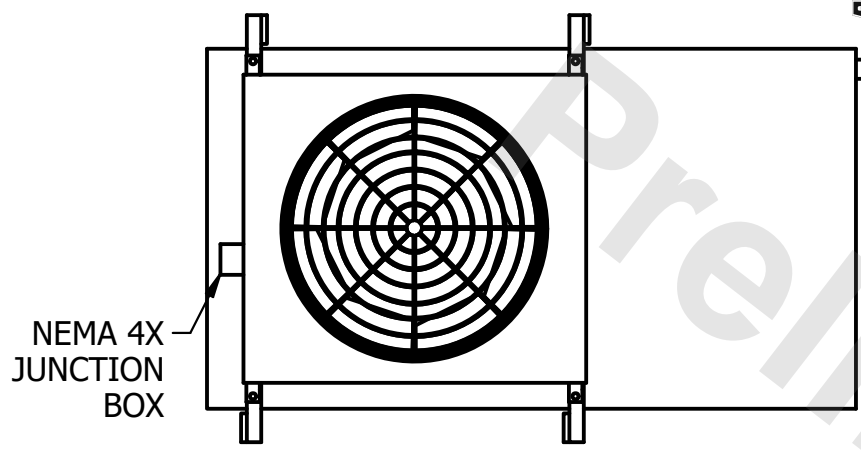

- NOTES:**
- 1) * = HANGER HOLE LOCATION.
 - 2) HANGER HOLES ARE FOR 3/4 INCH THREADED ROD.
 - 3) ALL DIMENSIONS ARE FOR REFERENCE AND SHOULD NOT BE USED FOR PREFABRICATION OF PIPING OR SUPPORTS.

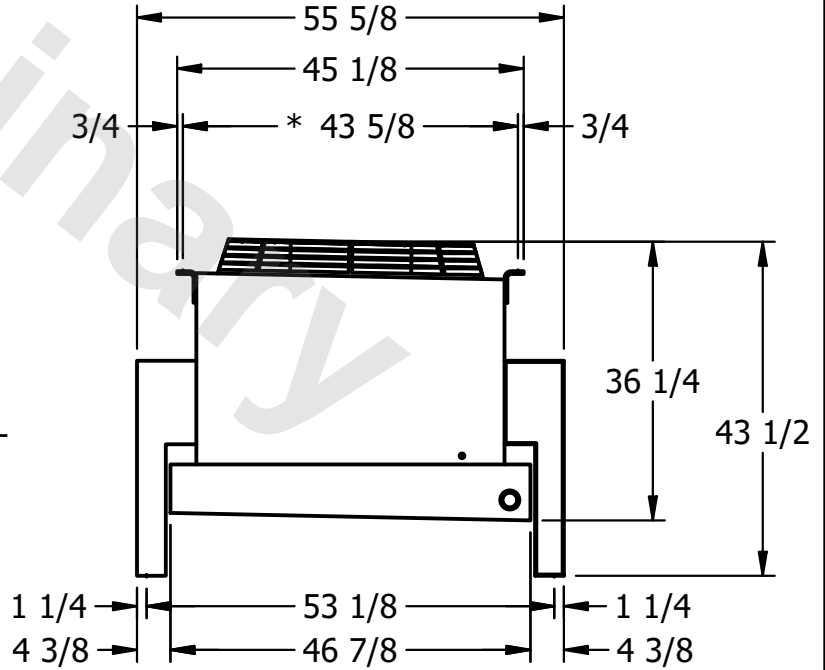
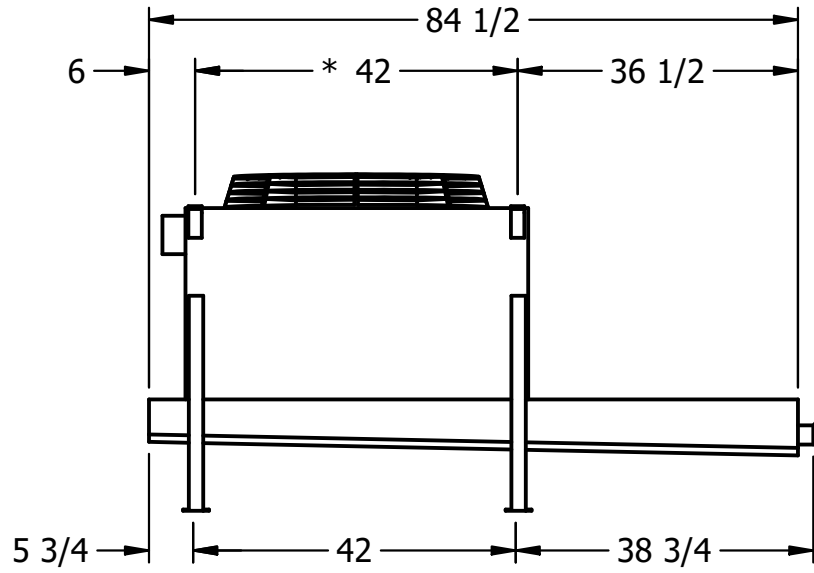

2" MPT DRAIN

PROJECT	ROOM	SHIPPING WEIGHT	500 lbs+ [230] kg+	OPERATING WEIGHT	530 lbs+ [245] kg+
---------	------	-----------------	--------------------	------------------	--------------------