

**CONFIDENTIAL**

This document is the property of Evapco, Inc. It should not be copied or disclosed without prior written authorization.

CUSTOMER	MODEL # U-SSTWE2-19S64F0100F1KA	SCALE N.T.S.	DWG. # USSTW2-SE-8	REV. 0	DATE 3/11/2025
----------	---------------------------------	--------------	--------------------	--------	----------------

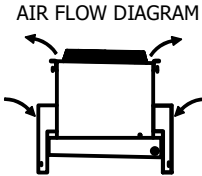
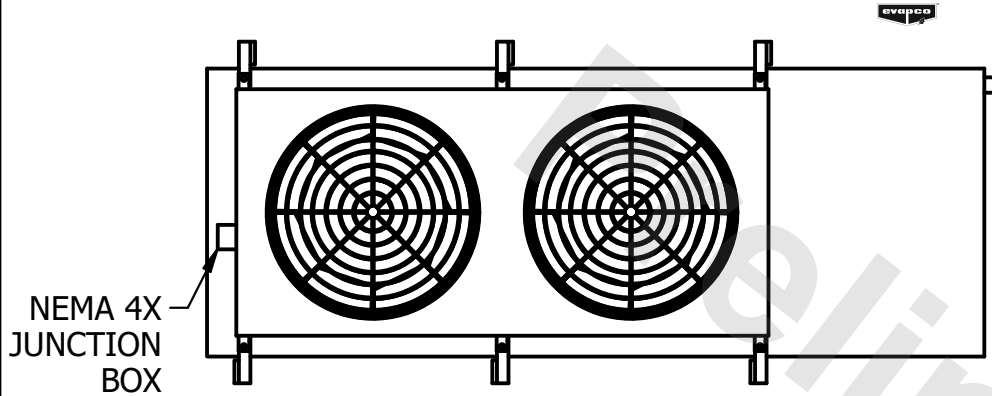

- NOTES:**
- 1) \* = HANGER HOLE LOCATION.
  - 2) HANGER HOLES ARE FOR 3/4 INCH THREADED ROD.
  - 3) ALL DIMENSIONS ARE FOR REFERENCE AND SHOULD NOT BE USED FOR PREFABRICATION OF PIPING OR SUPPORTS.

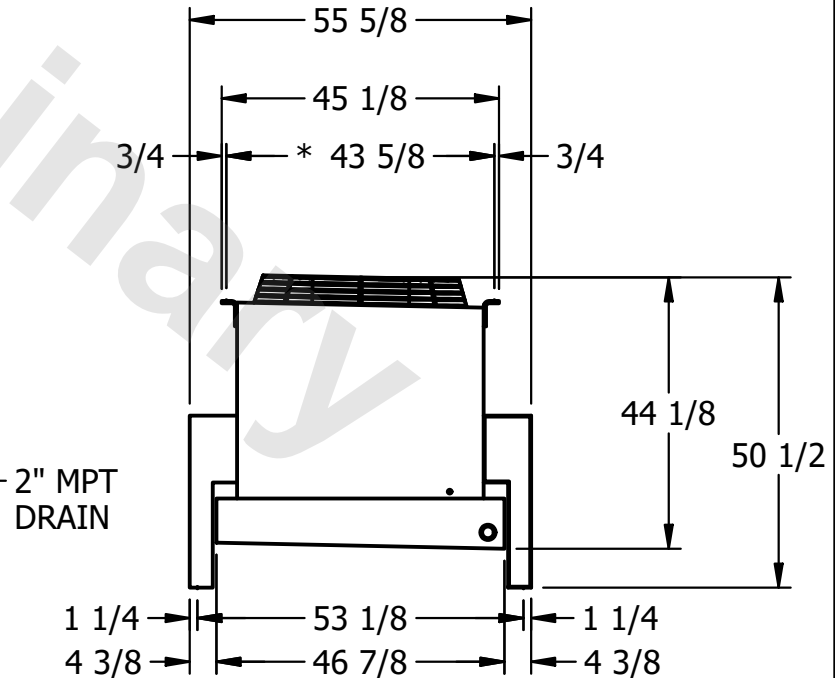
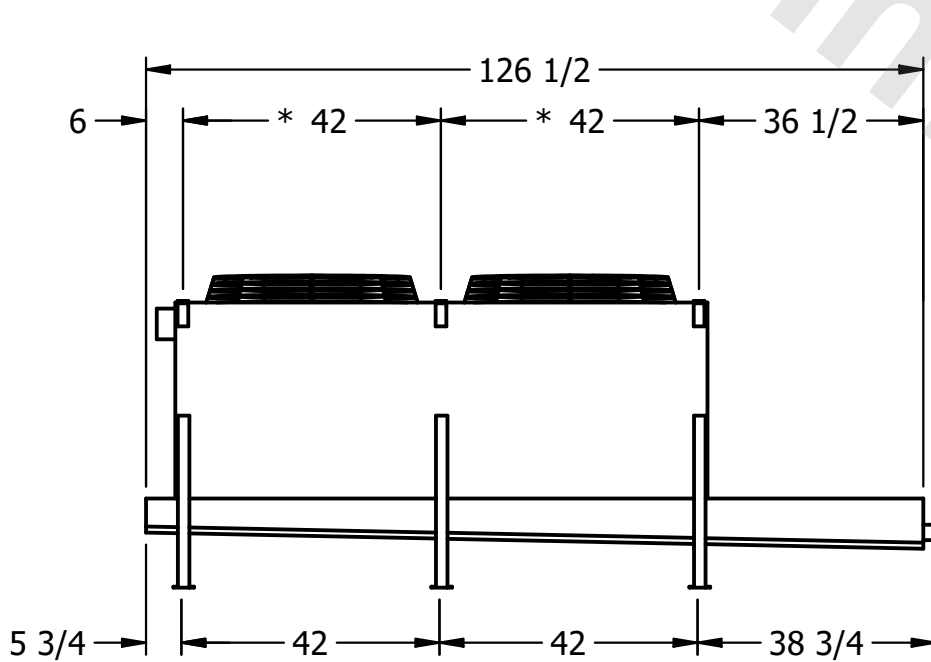

PROJECT	ROOM	SHIPPING WEIGHT 950 lbs+ [435] kg+	OPERATING WEIGHT 1080 lbs+ [490] kg+
---------	------	------------------------------------	--------------------------------------