

| | | |
|---------|-----------|-----------|
| UNIT | CONDENSER | |
| MODEL # | PMRC-816 | SCALE NTS |

EVAPCO, INC.

| | | | |
|----------|-------------------|-------|------------|
| DWG. # | CEWR122408-DRA-ST | REV | - |
| SERIAL # | | DATE: | 10/18/2024 |

- NOTES:**
1. (M) - FAN MOTOR LOCATION
 2. HEAVIEST SECTION IS UPPER SECTION
 3. MPT DENOTES MALE PIPE THREAD
FPT DENOTES FEMALE PIPE THREAD
BFW DENOTES BEVELED FOR WELDING
 4. +UNIT WEIGHT DOES NOT INCLUDE ACCESSORIES (SEE ACCESSORY DRAWINGS)
 5. 3/4" DIA. MOUNTING HOLES. REFER TO RECOMMENDED STEEL SUPPORT DRAWING.
 6. MAKE-UP WATER PRESSURE
20 psi MIN [137 kPa], 50 psi MAX [344 kPa]
 7. *- APPROXIMATE DIMENSIONS DO NOT USE FOR PRE-FABRICATION OF CONNECTING PIPING
 8. DIMENSIONS LISTED AS FOLLOWS: ENGLISH IN [METRIC] [mm]

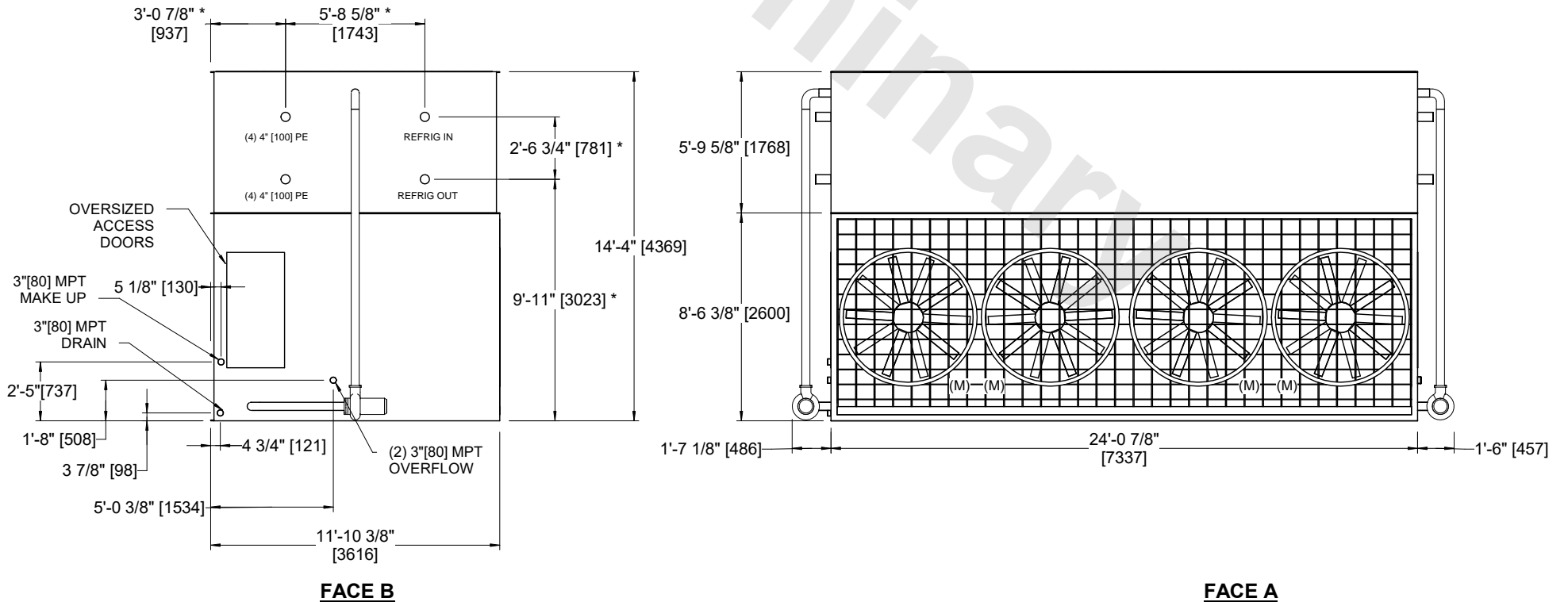
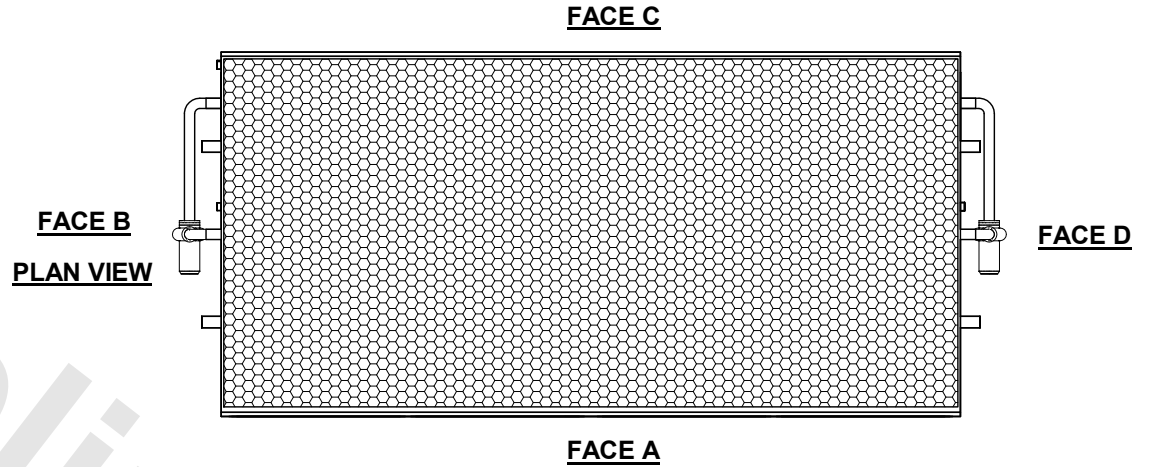

| | | | | | | | | | |
|-----------------|------------------------|------------------|------------------------|-------------------------|-----------------------|--------------------------|---|-----------|-----|
| SHIPPING WEIGHT | 34750 lbs+ [15765] kg+ | OPERATING WEIGHT | 44600 lbs+ [20235] kg+ | HEAVIEST SECTION WEIGHT | 12150 lbs+ [5515] kg+ | NO. OF SHIPPING SECTIONS | 3 | DRAWN BY: | JLG |
|-----------------|------------------------|------------------|------------------------|-------------------------|-----------------------|--------------------------|---|-----------|-----|