

UNIT	CONDENSER	
MODEL #	PMRC-536	SCALE NTS

EVAPCO, INC.

DWG. #	CEWR121208-DRA-ST	REV	-
SERIAL #		DATE:	10/19/2024

- NOTES:**
- (M) - FAN MOTOR LOCATION
 - HEAVIEST SECTION IS UPPER SECTION
 - MPT DENOTES MALE PIPE THREAD
FPT DENOTES FEMALE PIPE THREAD
BFW DENOTES BEVELED FOR WELDING
 - +UNIT WEIGHT DOES NOT INCLUDE ACCESSORIES (SEE ACCESSORY DRAWINGS)
 - 3/4" DIA. MOUNTING HOLES. REFER TO RECOMMENDED STEEL SUPPORT DRAWING.
 - MAKE-UP WATER PRESSURE
20 psi MIN [137 kPa], 50 psi MAX [344 kPa]
 - *- APPROXIMATE DIMENSIONS DO NOT USE FOR PRE-FABRICATION OF CONNECTING PIPING
 - DIMENSIONS LISTED AS FOLLOWS: ENGLISH IN [METRIC] [mm]

FACE B
PLAN VIEW

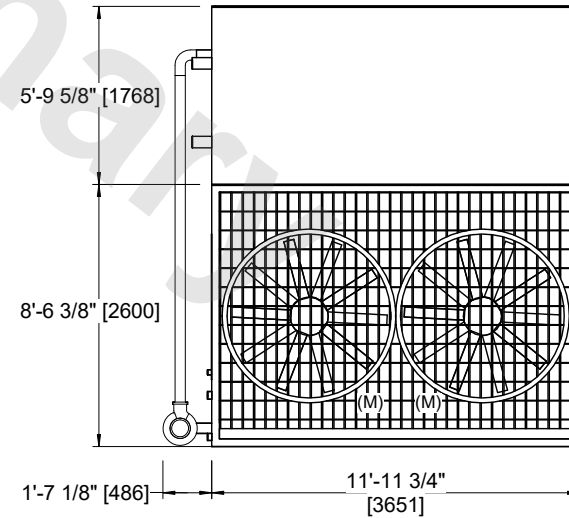
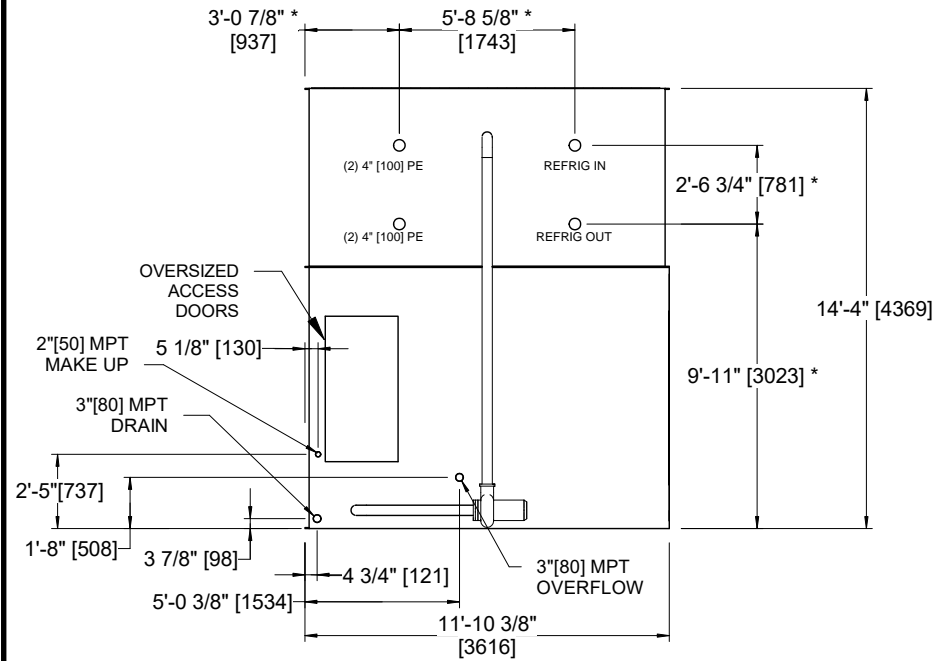

FACE B

FACE A

SHIPPING WEIGHT	18370 lbs+ [8335] kg+	OPERATING WEIGHT	23160 lbs+ [10510] kg+	HEAVIEST SECTION WEIGHT	12360 lbs+ [5610] kg+	NO. OF SHIPPING SECTIONS	2	DRAWN BY:	JLG
-----------------	-----------------------	------------------	------------------------	-------------------------	-----------------------	--------------------------	---	-----------	-----