



LTC TRANSFER CONTROLLER

Installation – Operation – Maintenance
Manual

8-14-2018

REV – 0.9

INDEX

KEYPAD NAVIGATION	6
SCREEN NAVIGATION CHARTS	7
OVER VIEW SCREEN.....	13
MAIN MENU:	13
SYSTEM STATUS	14
Vessel Pressure:.....	15
Pump 1 Pressure:	15
Pump Motor Amps:	15
Pump 1 Bearing Mon.:	16
Pump 2 Pressure:	16
Pump 2 Motor Amps:	16
Pump 2 Bearing Mon.:	16
Transfers:.....	16
Pump VFD Run:.....	17
Vent Solenoid:	17
Pump 2 Select:	17
Hi Level Shutdn:	17
VFD Not Ready:.....	17
Alarm Code:.....	17
SETPOINTS.....	17
Transfer On:	18
Transfer Off:	18
Vent Solenoid Delay:	18
Liquid Transfer Mode:.....	18
Select Lead Pump:.....	19
High Level Shutdn:	19
High Level Shutdn Delay:.....	19
High Level Alarm:	19
High Level Alarm Delay:.....	19
Low Level Alarm:	19
Low Level Alarm Delay:.....	20

Low Motor Amps Alarm:.....	20
Low Motor Amps Alarm Delay:.....	20
CONFIGURATIONS	21
Number Of Pumps:	22
Communications:.....	22
Communications Device Addr.:	22
Communications BAUD RATE:	22
Communications Packets Ok:.....	22
Communications Packets Bad:.....	22
Input Sensors:.....	22
Channel #1 Vessel Level:	23
High End:.....	23
Low End:.....	23
Offset:.....	23
Channel #2 Vessel Pressure:.....	23
High End:.....	23
Low End:.....	23
Offset:.....	24
Channel #3 Pump #1 Pressure:.....	24
High End:.....	24
Low End:.....	24
Offset:.....	24
Channel #4 Pump #1 Bearing Mon:	24
Low End:.....	25
Offset:.....	25
High End:.....	25
Low End:.....	25
Offset:.....	25
Channel #6 Pump #2 Pressure:.....	25
High End:.....	26
Low End:.....	26
Offset:.....	26
Channel #7 Pump #2 Bearing Mon:	26

High End:	26
Low End:	26
Offset:	26
Passcode Setup:	27
Passcode:	27
Circuit Board Temperature:	27
Circuit Board Heater:	27
Reset All Settings To Their Defaults:	27
ABOUT SCREEN	28
SECURITY:	28
ALARM CODE TABLES	29
I/O DESCRIPTIONS	30
DIGITAL OUTPUTS	30
DIGITAL INPUTS	31
ANALOG OUTPUTS	33
DISPLAY ASSEMBLY INTERFACE	34
DIGITAL I/O BOARD	35
HARDWARE SPECIFICATIONS	36
COMMUNICATIONS ADDENDUM	38
Setpoints:	38
Configuration Settings:	39
System Status:	40
Digital Outputs:	40
Digital Inputs:	40
Analog Inputs:	40
Analog Outputs Board 1:	41
Analog Board 1 - Transducer Settings:	41
Analog – Outputs (Min and Max Count Limits):	42
Modbus Communications:	43

KEYPAD NAVIGATION

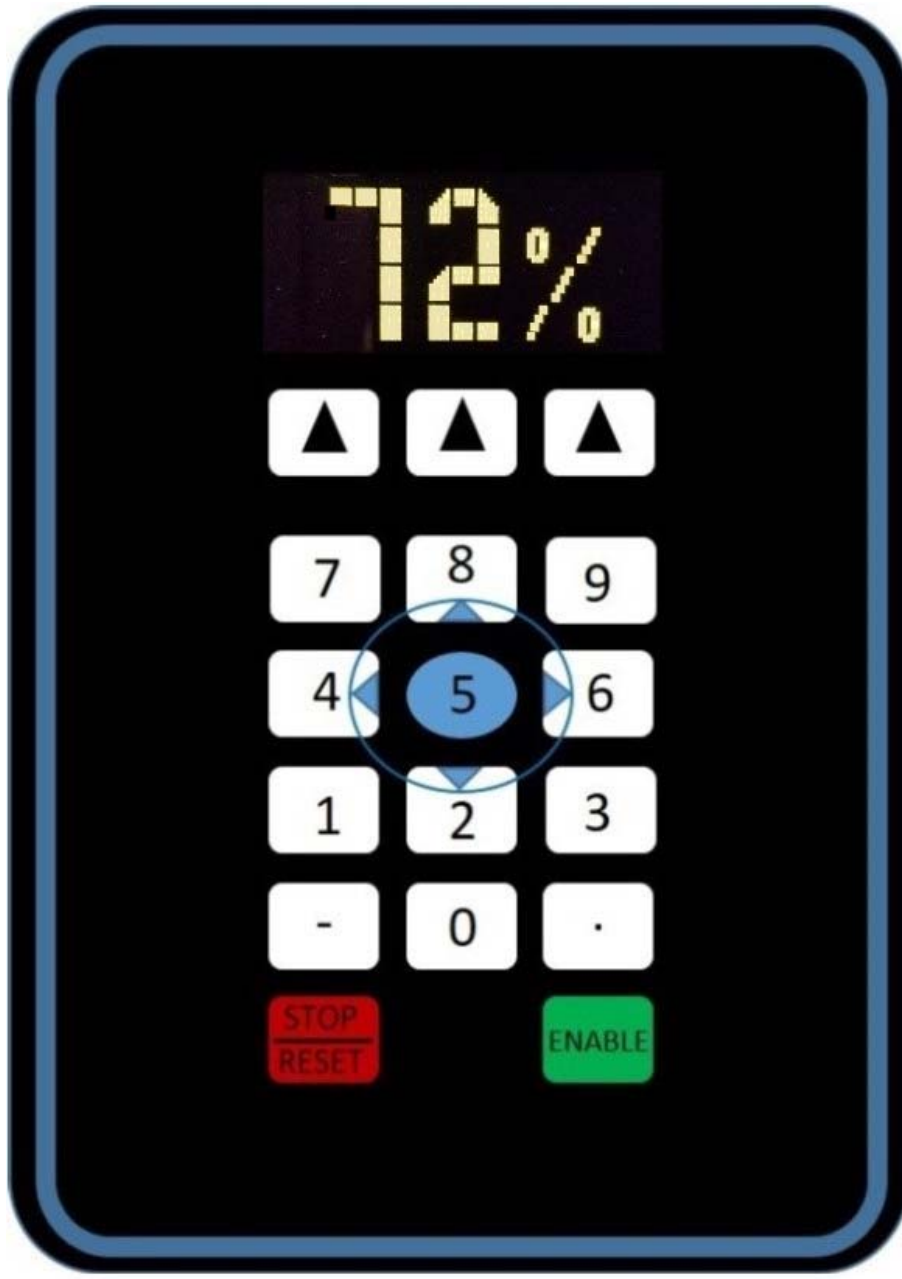

Menu navigation is accomplished by pressing the triangular buttons directly below the display, or the numeric direction buttons 8=up, 2=down, 4=left, 6=right and 5=ENTER.

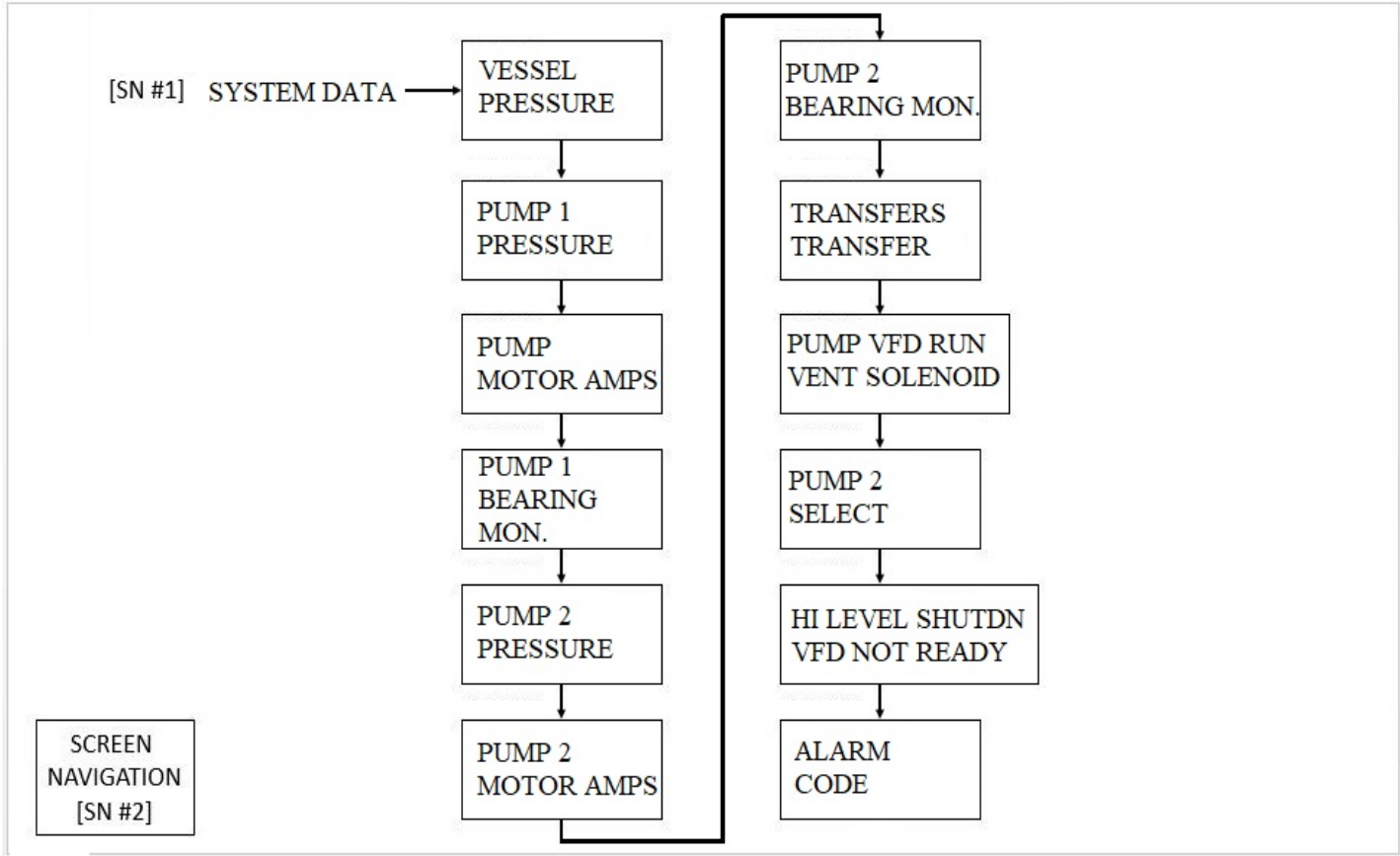

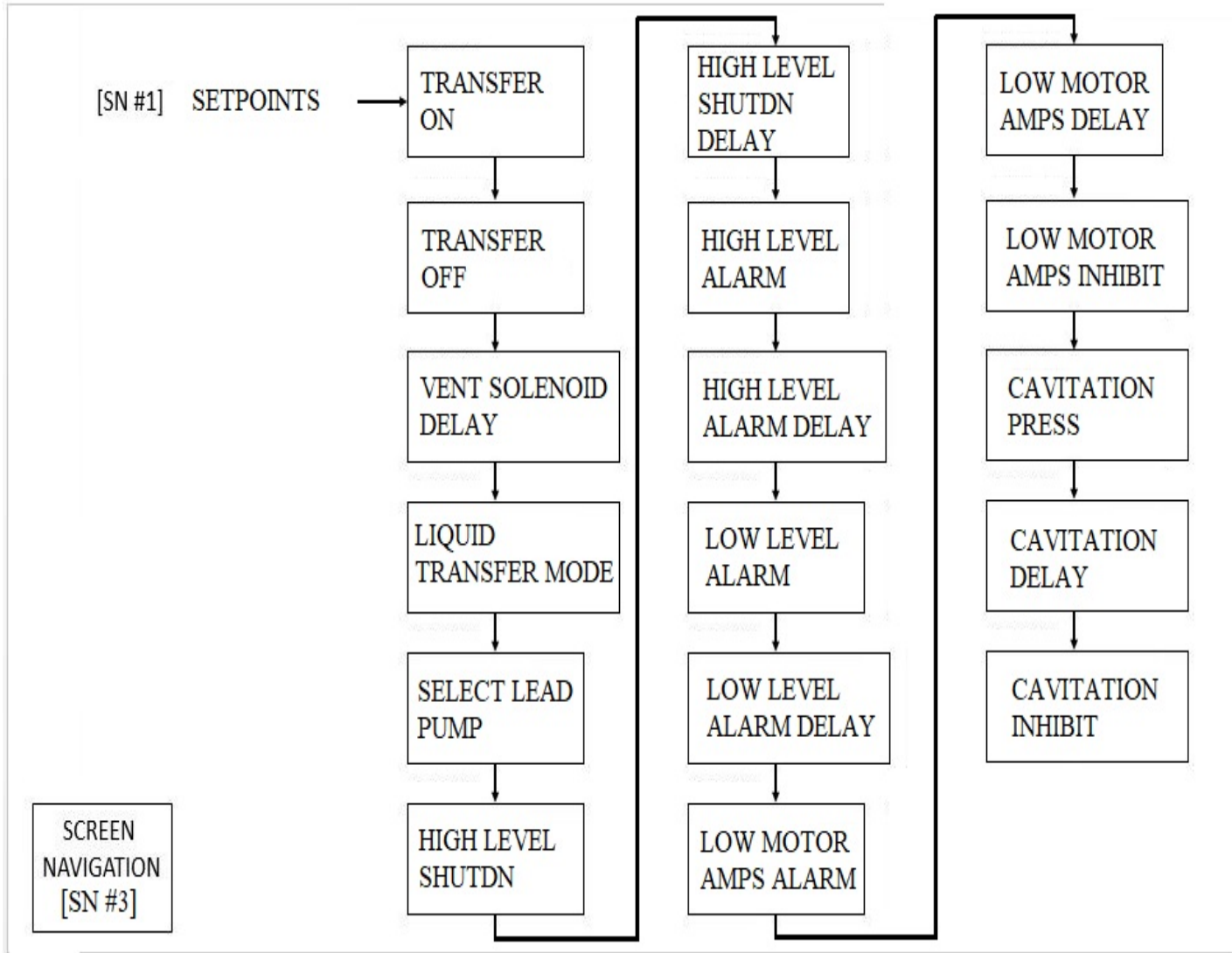

[SN #1] CONFIGURATIONS

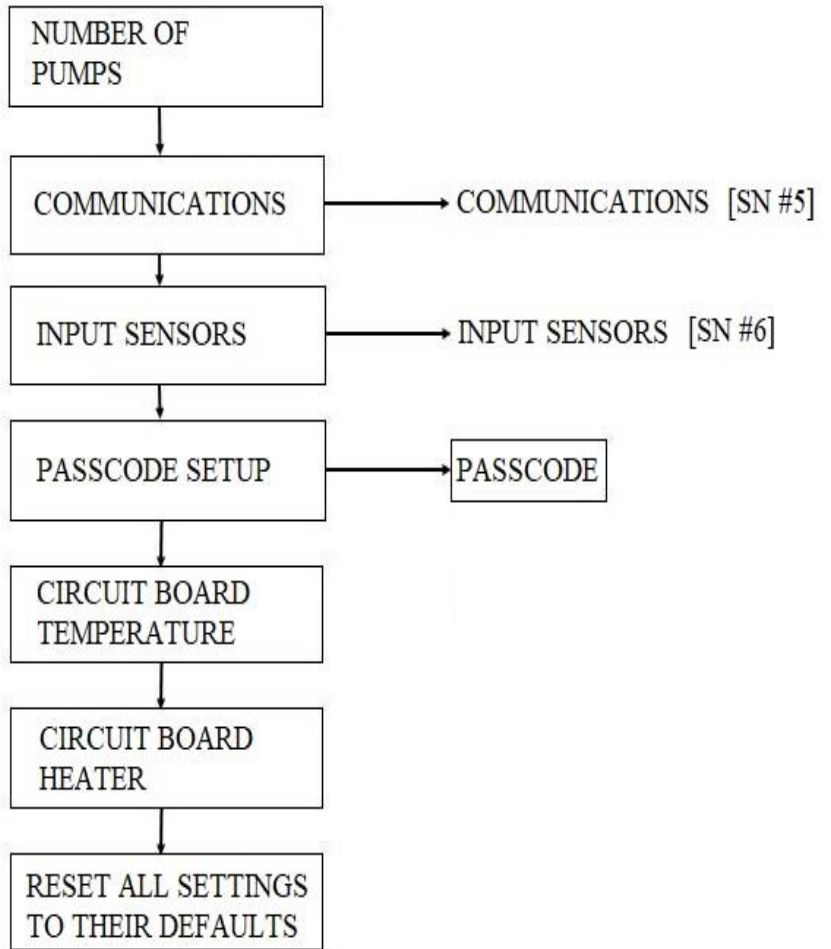

SCREEN
NAVIGATION
[SN #4]

[SN #4] COMMUNICATIONS

SCREEN
NAVIGATION
[SN #5]

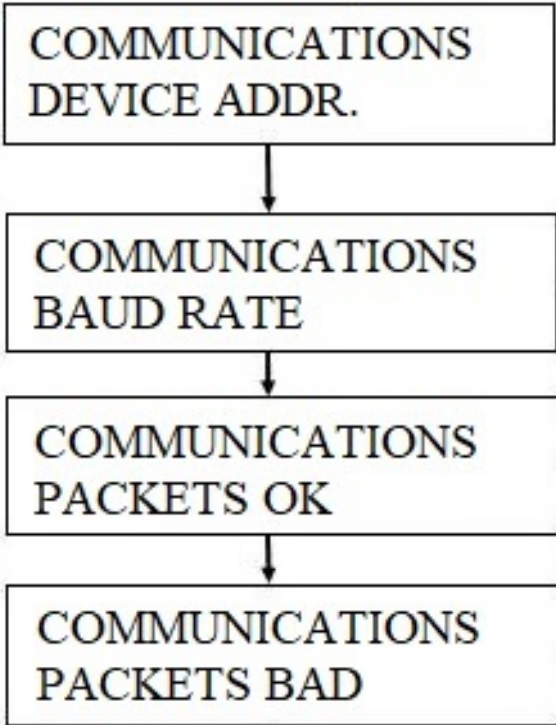

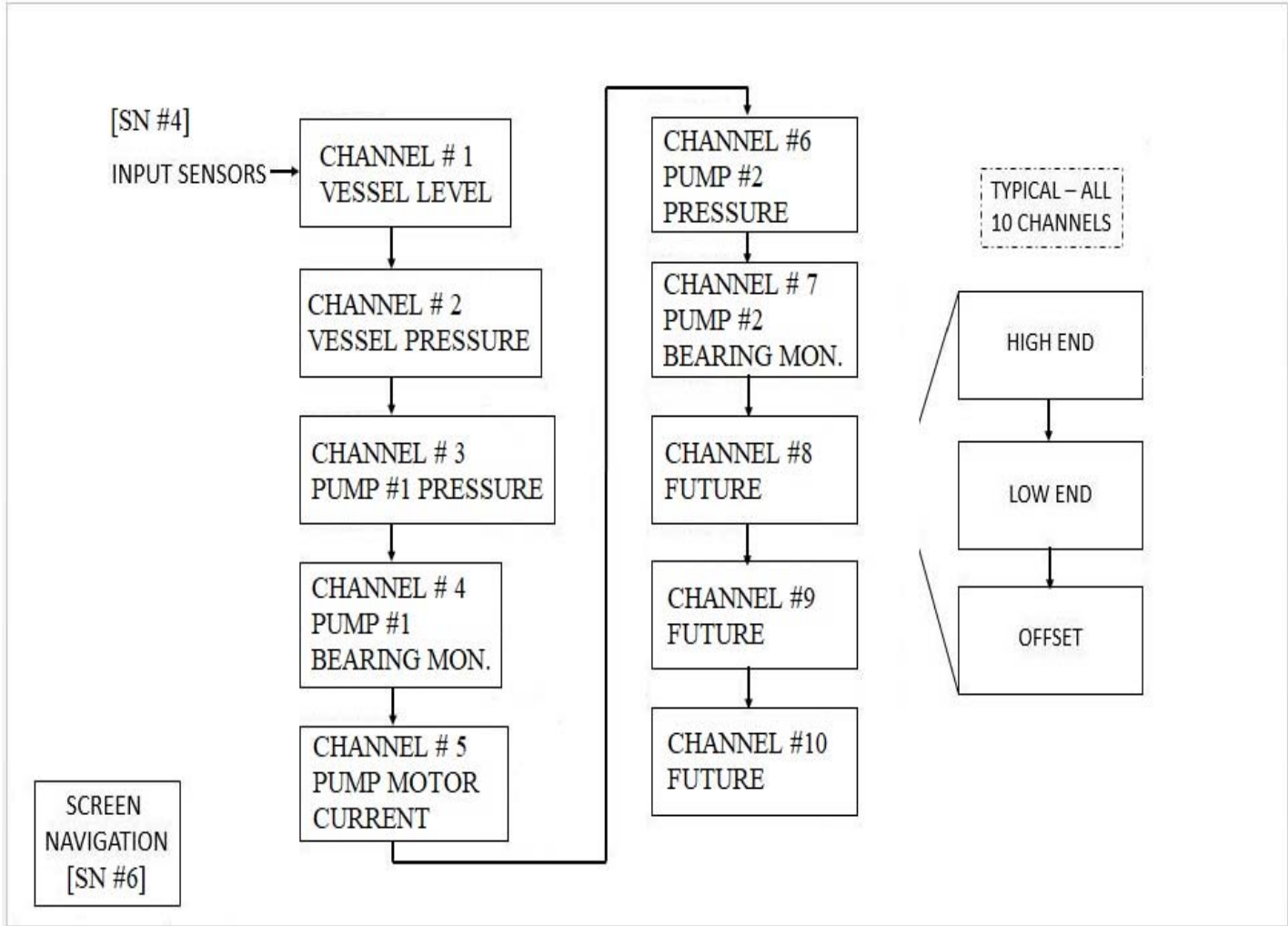

OVER VIEW SCREEN

The over view screen provides general information on the operating modes and conditions of the system.

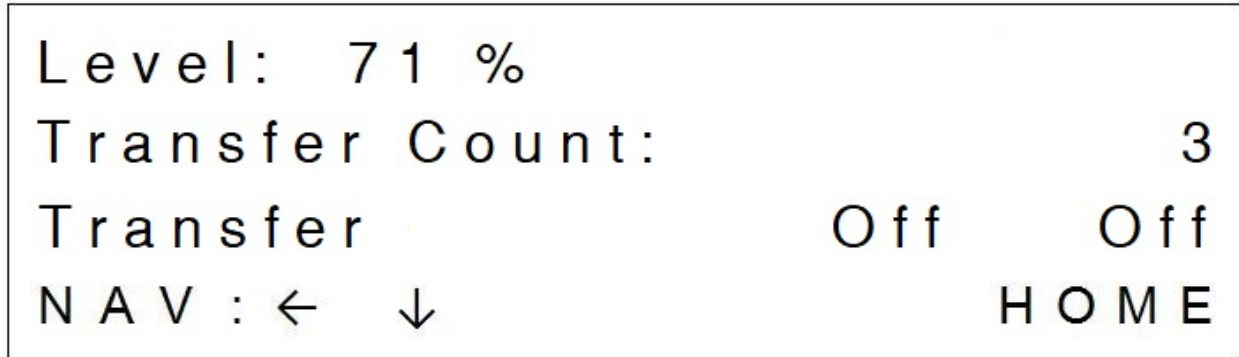

Over View Screen: This screen has four main areas.

- This will display the Current Level as a percent.
- The second line displays the current number of transfers.
- The third line displays the current transfer mode and status:
Mode - Off, Auto and Man.
Status – Off, On, INH (Inhibit. Either Amps or Cavitation)
- The normally blank area in the lower middle area of the fourth line will indicate:
 - “ALARM” (when in alarm), “CUTOUT” (when in cutout). “CAV.” (when in cavitation).
 - Passcode access status. Passcode (when enabled) may show either “ADMIN” or “USER”. When “ALARM” is flashing. Pressing the triangle button below the “ALARM” display will take the operator to the safety menu.
 - Pressing the triangle button below “ADMIN or “USER” will allow the operator to immediately clear the remaining time an operator is allowed to access settings.

1. **MENU** – Selects the “Main MENU” screen.

MAIN MENU:

The main menu is comprised of a list of 4 menu selections.

- 1) System Status

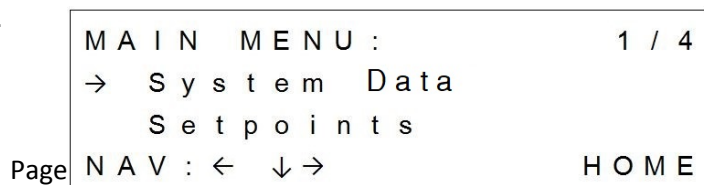

- 2) Setpoints
- 3) Configurations
- 4) About

System Status – Allows the operator to examine all control panel system data. Such as temperature(s), pressure(s), safety information and digital and analog outputs.

Setpoints – Gives the operator access to the main control panel operational setpoints.

Configurations – Contains system control settings that define the general operation of the system. Such as operating mode, number of pumps. These settings are generally considered “factory” settings.

About – This screen presents the operator with the program version, release date, (Modbus device ID, BAUD rate) of the RS485 serial communications port.

SYSTEM STATUS

The system status menu is comprised of 12 selections.

- 1) Vessel Pressure
- 2) Pump 1 Pressure
- 3) Pump Motor Amps

- 4) Pump 1 Bearing Mon.
- 5) Pump 2 Pressure
- 6) Pump 2 Motor Amps
- 7) Pump 2 Bearing Mon.
- 8) Transfer Status
 - a. Transfer count (Current count of transfer events)
 - b. Transfer Mode and Status (Operating Mode and run Status)
- 9) Digital Outputs
 - a. Pump VFD Run (On, Off)
 - b. Vent Solenoid (On, Off)
- 10) Pump 2 Selection
- 11) Digital Inputs
 - a. Hi Level Shutdn
 - b. VFD Not Ready
- 12) Alarm Code

Vessel Pressure:

Displays the current "Vessel Pressure".

Level: 71 %	1 / 12
Vessel Pressure	
[120 PSIG]	
NAV : ← ↓	HOME

Pump 1 Pressure:

Displays the current "Pump 1 Pressure".

Level: 71 %	2 / 12
Pump 1 Pressure	
[147 PSIG]	
NAV : ← ↑ ↓	HOME

Pump Motor Amps:

Displays the current "Pump Motor Amps".

Level: 71 %	3 / 12
Pump Motor Amps	
[1.2 Amps]	
NAV : ← ↑ ↓	HOME

Pump 1 Bearing Mon.:

Displays the current "Pump 1 Bearing Mon."

Level: 71 %	4 / 12
Pump 1 Bearing Mon.	
[.51]	
NAV : ← ↑ ↓	HOME

Pump 2 Pressure:

Displays the current "Pump 2 Pressure".

Level: 71 %	5 / 12
Pump 2 Pressure	
[154 PSIG]	
NAV : ← ↑ ↓	HOME

Pump 2 Motor Amps:

Displays the current "Pump 2 Motor Amps".

Level: 71 %	6 / 12
Pump 2 Motor Amps	
[1.2 Amps]	
NAV : ← ↑ ↓	HOME

Pump 2 Bearing Mon.:

Displays the current "Pump 2 Bearing Mon."

Level: 71 %	7 / 12
Pump 2 Bearing Mon.	
[.51]	
NAV : ← ↑ ↓	HOME

Transfers:

Displays the current "Transfers" and the current "Transfer" mode and run status. Reset to zero the current count by pressing the keypad arrow below the word "RESET".

Level: 71 %	8 / 12
Transfers	
3	
Transfer	Off Off
NAV : ← ↑ ↓	RESET HOME



Pump VFD Run:

Vent Solenoid:

Displays the current "Pump VFD Run" status and the current "Vent Solenoid" status.

```

Level: 71 %                               9 / 12
Pump VFD RUN                               [Off]
Vent Solenoid                              [Off]
NAV : ← ↑ ↓                               HOME

```

Pump 2 Select:

Displays the current "Pump 2 Select" status.

```

Level: 71 %                               10 / 12
Pump 2 Select[Off]
NAV : ← ↑ ↓                               HOME

```

Hi Level Shutdn:

VFD Not Ready:

Displays the current "Hi Level Shutdn" and "VFD Not Ready" digital Inputs status.

```

Level: 71 %                               11 / 12
Hi Level Shutdn [Off]
VFD Not Ready [Off]
NAV : ← ↑ ↓                               HOME

```

Alarm Code:

Displays the current "Alarm Code" message and code. See "Alarm Code Tables".

```

Level: 71 %                               12 / 12
Alarm Code [ 0]
NAV : ← ↑                               HOME

```

SETPOINTS

This menu is comprised of a list of 17 selections.

- 1) Transfer On
- 2) Transfer Off
- 3) Vent Solenoid Delay
- 4) Liquid Transfer Mode
- 5) Select Lead Pump
- 6) High Level Shutdn

```

MAIN MENU :                               2 / 4
→ Setpoints
   C o n f i g u r a t i o n s
NAV : ← ↑ ↓ →                             HOME

```

- 7) High Level Shutdn Delay
- 8) High Level Alarm
- 9) High Level Alarm Delay
- 10) Low Level Alarm
- 11) Low Level Alarm Delay
- 12) Low Motor Amps Alarm
- 13) Low Motor Amps Delay
- 14) Low Motor Amps Inhibit
- 15) Cavitation Press
- 16) Cavitation Delay
- 17) Cavitation Inhibit

Transfer On:

Sets the “**Transfer On**” setpoint.

```

Set points :                1 / 17
→ Transfer On
   [ 70% ]
NAV : ← ↓ EDIT HOME
  
```

Transfer Off:

Sets the “**Transfer Off**” setpoint.

```

Set points :                2 / 17
→ Transfer Off
   [ 60% ]
NAV : ← ↑ ↓ EDIT HOME
  
```

Vent Solenoid Delay:

Sets the “**Vent Solenoid Delay**” setpoint.

```

Set points :                3 / 17
→ Vent Solenoid
   Delay [ 3 Seconds ]
NAV : ← ↑ ↓ EDIT HOME
  
```

Liquid Transfer Mode:

Sets the “**Liquid Transfer Mode**” setpoint.

```

Set points :                4 / 17
→ Liquid Transfer
   Mode [ Off ]
NAV : ← ↑ ↓ EDIT HOME
  
```

Select Lead Pump:

Sets the “**Select Lead Pump**” setpoint.

```
Set points :          5 / 17
→ Select Lead Pump
   [NA] 1 Pump Config
NAV : ← ↑ ↓   EDIT   HOME
```

High Level Shutdn:

Sets the “**High Level Shutdn**” setpoint.

```
Set points :          6 / 17
→ High Level Shutdn
   [ 90 %]
NAV : ← ↑ ↓   EDIT   HOME
```

High Level Shutdn Delay:

Sets the “**High Level Shutdn Delay**” setpoint.

```
Set points :          7 / 17
→ High Level Shutdn
   Delay[ 10 Seconds]
NAV : ← ↑ ↓   EDIT   HOME
```

High Level Alarm:

Sets the “**High Level Alarm**” setpoint.

```
Set points :          8 / 17
→ High Level Alarm
   [ 80 %]
NAV : ← ↑ ↓   EDIT   HOME
```

High Level Alarm Delay:

Sets the “**High Level Alarm Delay**” setpoint.

```
Set points :          9 / 17
→ High Level Shutdn
   Delay[  5 Seconds]
NAV : ← ↑ ↓   EDIT   HOME
```

Low Level Alarm:

Sets the “**Low Level Alarm**” setpoint.

```
Set points :         10 / 17
→ Low Level Alarm
   [ 10 %]
NAV : ← ↑ ↓   EDIT   HOME
```

Low Level Alarm Delay:

Sets the “**Low Level Alarm Delay**” setpoint.

```
Set points :           11 / 17
→ Low Level Alarm
   Delay [ 15 Seconds]
NAV : ← ↑ ↓   EDIT   HOME
```

Low Motor Amps Alarm:

Sets the “**Low Motor Amps Alarm**” setpoint.

```
Set points :           12 / 17
→ Low Motor Amps
   Alarm [ 1.0 Amps]
NAV : ← ↑ ↓   EDIT   HOME
```

Low Motor Amps Alarm Delay:

Sets the “**Low Motor Amps Alarm Delay**” setpoint.

```
Set points :           13 / 17
→ Low Motor Amps
   Delay [ 10 Seconds]
NAV : ← ↑ ↓   EDIT   HOME
```

Low Motor Amps Inhibit:

Sets the “**Low Motor Amps Inhibit**” setpoint.

```
Set points :           14 / 17
→ Low Motor Amps
   Inhibit [ 60 Seconds]
NAV : ← ↑ ↓   EDIT   HOME
```

Cavitation Press:

Sets the “**Cavitation Press**” setpoint.

```
Set points :           15 / 17
→ Cavitation Press
   [ 20 PSID]
NAV : ← ↑ ↓   EDIT   HOME
```

Cavitation Delay:

Sets the “**Cavitation Delay**” setpoint.

```
Setpoints :           16 / 17
→ Cavitation Delay
   [ 60 Seconds]
NAV : ← ↑ ↓   EDIT   HOME
```

Cavitation Inhibit:

Sets the “**Cavitation Inhibit**” setpoint.

```
Setpoints :           17 / 17
→ Cavitation Inhibit
   [ 60 Seconds]
NAV : ← ↑       EDIT   HOME
```

CONFIGURATIONS

This menu is comprised of a list of 7 selections.

1. Number Of Pumps
2. Communications
3. Input Sensors
4. Passcode Setup
5. Circuit Board Temperature
6. Circuit Board Heater
7. Reset All Settings to Their Defaults

```
MAIN MENU :           3 / 4
→ C o n f i g u r a t i o n s
   A b o u t
NAV : ← ↑ ↓ →       HOME
```

Number Of Pumps:

Indicates the “**Number Of Pumps**” setpoint. Possible settings: 1 through 2.

```

C o n f i g u r a t i o n s :      1 / 7
→  N u m b e r O f P u m p s      [ 1 ]

N A V : ← ↓   E D I T   H O M E

```

Communications:

Displays the “**Communications**” menu.

```

C o n f i g u r a t i o n s :      2 / 7
→  C o m m u n i c a t i o n s
    I n p u t S e n s o r s

N A V : ← ↑ ↓ →   H O M E

```

Communications Device Addr.:

Sets the “**Communications Device Address.**” The device address is set to equal the rotary DIP switches on the I/O board. ADDR-HI, ADDR-LO.

```

C o n f i g u r a t i o n s :      1 / 4
→  C o m m u n i c a t i o n s
    D e v i c e A d d r . [ 1 ]

N A V : ← ↓ ( S W 1 - 2 ) H O M E

```

Communications BAUD RATE:

Sets the “**Communications BAUD RATE**”. 2400, 4800, 9600, 19200, 38400, 57600.

```

C o n f i g u r a t i o n s :      2 / 4
→  C o m m u n i c a t i o n s
    B A U D R A T E [ 1 9 2 0 0 ]

N A V : ← ↑ ↓   E D I T   H O M E

```

Communications Packets Ok:

Indicates the “**Communications Packets Ok**” counter. Used for communications diagnostics purposes.

```

C o n f i g u r a t i o n s :      3 / 4
→  C o m m u n i c a t i o n s
    P a c k e t s O k      0 0 0 0 0

N A V : ← ↑ ↓   Z E R O   H O M E

```

Communications Packets Bad:

Sets the “**Communications Packets Bad**” counter. Used for communications diagnostics purposes.

```

C o n f i g u r a t i o n s :      4 / 4
→  C o m m u n i c a t i o n s
    P a c k e t s B a d    0 0 0 0 0

N A V : ← ↑   Z E R O   H O M E

```

Input Sensors:

Displays the “**Input Sensors**” menu.

```

C o n f i g u r a t i o n s :      3 / 7
→  I n p u t S e n s o r s
    P a s s c o d e S e t u p

N A V : ← ↑ ↓ →   H O M E

```

Channel #1 Vessel Level:

Displays the “Channel #1 Vessel Level” menu.

```
Input Sensors :
→ Channel # 1
Vessel Level
NAV : ← ↓ → HOME
```

High End:

Sets the “High End” range of the sensor.

```
Input Channel 1
→ High End : [ 100.0 ]
Low End : [ .0 ]
NAV : ← ↓ EDIT HOME
```

Low End:

Sets the “Low End” range of the sensor.

```
Input Channel 1
→ Low End : [ .0 ]
Offset : [ .0 ]
NAV : ← ↓ EDIT HOME
```

Offset:

Sets the “Offset” for calibration of the sensor.

```
Input Channel 1
→ Offset : [ .0 ]
NAV : ← ↑ EDIT HOME
```

Channel #2 Vessel Pressure:

Displays the “Channel #2 Vessel Pressure” setpoints menu.

```
Input Sensors :
→ Channel # 2
Vessel Pressure
NAV : ← ↑ ↓ → HOME
```

High End:

Sets the “High End” range of the sensor.

```
Input Channel 2
→ High End : [ 500.0 ]
Low End : [ - .0 ]
NAV : ← ↓ EDIT HOME
```

Low End:

Page

```
Input Channel 2
→ Low End : [ .0 ]
Offset : [ .0 ]
NAV : ← ↑ ↓ EDIT HOME
```

Sets the “**Low End**” range of the sensor.

Offset:

Sets the “**Offset**” for calibration of the sensor.

```
Input Channel 2
→ Offset : [ . 0 ]

NAV : ← ↑ EDIT HOME
```

Channel #3 Pump #1 Pressure:

Displays the “**Channel #3 Pump #1 Pressure**” setpoints menu.

```
Input Sensors :
→ Channel # 3
Pump #1 Pressure
NAV : ← ↑ ↓ → HOME
```

High End:

Sets the “**High End**” range of the sensor.

```
Input Channel 3
→ High End : [ 5 0 0 . 0 ]
Low End : [ . 0 ]
NAV : ← ↓ EDIT HOME
```

Low End:

Sets the “**Low End**” range of the sensor.

```
Input Channel 3
→ Low End : [ . 0 ]
Offset : [ . 0 ]
NAV : ← ↑ ↓ EDIT HOME
```

Offset:

Sets the “**Offset**” for calibration of the sensor.

```
Input Channel 3
→ Offset : [ . 0 ]

NAV : ← ↑ EDIT HOME
```

Channel #4 Pump #1 Bearing Mon:

Displays the “**Channel #4 Pump #1 Bearing Mon**” setpoints menu.

```
Input Sensors :
→ Channel # 4
Pump #1 Bearing Mon
NAV : ← ↑ ↓ → HOME
```

High End:

Sets the “**High End**” range of the sensor.

```
Input Channel 4
→ High End : [ 1 0 0 . 0 ]
Low End : [ . 0 ]
NAV : ← ↓ EDIT HOME
```

Low End:

Sets the “Low End” range of the sensor.

```

Input Channel 4
→ Low End : [ . 0 ]
Offset : [ . 0 ]
NAV : ← ↑ ↓ EDIT HOME

```

Offset:

Sets the “Offset” for calibration of the sensor.

```

Input Channel 4
→ Offset : [ . 0 ]

NAV : ← ↑ EDIT HOME

```

Channel #5 Humidity:

Displays the “Channel #5 Humidity” setpoints menu.

```

Input Sensors :
→ Channel # 5
Pump Motor Current
NAV : ← ↑ ↓ → HOME

```

High End:

Sets the “High End” range of the sensor.

```

Input Channel 5
→ High End : [ 175 . 0 ]
Low End : [ . 0 ]
NAV : ← ↓ EDIT HOME

```

Low End:

Sets the “Low End” range of the sensor.

```

Input Channel 5
→ Low End : [ . 0 ]
Offset : [ . 0 ]
NAV : ← ↑ ↓ EDIT HOME

```

Offset:

Sets the “Offset” for calibration of the sensor.

```

Input Channel 5
→ Offset : [ . 0 ]

NAV : ← ↑ EDIT HOME

```

Channel #6 Pump #2 Pressure:

Displays the “Channel #6 Pump #2 Pressure” setpoints menu.

```

Input Sensors :
→ Channel # 6
Pump # 2 Pressure
NAV : ← ↑ → HOME

```

High End:

Sets the “High End” range of the sensor.

```

Input Channel 6
→ High End : [ 500.0 ]
  Low End : [ - .0 ]
NAV : ← ↓ EDIT HOME

```

Low End:

Sets the “Low End” range of the sensor.

```

Input Channel 6
→ Low End : [ .0 ]
  Offset : [ .0 ]
NAV : ← ↑ ↓ EDIT HOME

```

Offset:

Sets the “Offset” for calibration of the sensor.

```

Input Channel 6
→ Offset : [ .0 ]
NAV : ← ↑ EDIT HOME

```

Channel #7 Pump #2 Bearing Mon:

Displays the “Channel #7 Pump #2 Bearing Mon” setpoints menu.

```

Input Sensors :
→ Channel # 7
  Pump # 2 Bearing Mon
NAV : ← ↑ → HOME

```

High End:

Sets the “High End” range of the sensor.

```

Input Channel 7
→ High End : [ 100.0 ]
  Low End : [ .0 ]
NAV : ← ↓ EDIT HOME

```

Low End:

Sets the “Low End” range of the sensor.

```

Input Channel 7
→ Low End : [ .0 ]
  Offset : [ .0 ]
NAV : ← ↑ ↓ EDIT HOME

```

Offset:

Page

```

Input Channel 7
→ Offset : [ .0 ]
NAV : ← ↑ EDIT HOME

```

Sets the “**Offset**” for calibration of the sensor.

Passcode Setup:

Displays the “**Passcode Setup**” Menu

```
 C o n f i g u r a t i o n s :   4 / 7
→ P a s s c o d e   S e t u p
   C i r c u i t   B o a r d
N A V : ← ↑ ↓ →                H O M E
```

Passcode:

Sets the “**Passcode**”.

```
 C o n f i g u r a t i o n s :   4 / 7
→ P a s s c o d e   S e t u p
   C i r c u i t   B o a r d
N A V : ← ↑ ↓ →                H O M E
```

Circuit Board Temperature:

Indicates the “**Circuit Board Temperature**”.
Used for diagnostics purposes.

```
 C o n f i g u r a t i o n s :   5 / 7
→ C i r c u i t   B o a r d
   T e m p e r a t u r e [  8 7 ° F ]
N A V : ← ↑ ↓                H O M E
```

Circuit Board Heater:

Indicates the status of the internal “**Circuit Board Heater**”. (On or OFF)

```
 C o n f i g u r a t i o n s :   6 / 7
→ C i r c u i t   B o a r d
   H e a t e r                [ O f f ]
N A V : ← ↑ ↓                H O M E
```

Reset All Settings To Their Defaults:

Sets the “**Reset All Settings To Their Defaults**”. This allows an operator to reset all panel settings to their factory defaults.

```
 C o n f i g u r a t i o n s :   7 / 7
→ R e s e t   A l l   S e t t i n g s
   T o   T h e i r   D e f a u l t s
N A V : ← ↑     E D I T     H O M E
```

ABOUT SCREEN

Display Screen for the “About Screen”.

The “about” screen presents the operator with the current installed program version, release date, (Modbus device ID, BAUD rate of the RS485 serial communications port).

P r o g V e r s i o n :	0 . 9 0
R e l . D a t e	0 8 - 0 8 - 2 0 1 8
D e v I D :	1 B A U D : 1 9 2 0 0
N A V : ←	HOME

SECURITY:

If the panel is “Locked”. This screen permits the operator to enter a “user” or “admin” passcode. If the entered passcode matches the user or admin passcodes then the panel will be unlocked allowing the operator to access and change settings. The panel will

*	E n t e r P a s s c o d e	*
	[]	
	L o c k e d	
C A N C E L	B A C K S P	E N T E R

re-enable the lock once the operator stops accessing the settings for 5 minutes. Note that the panel will be in the locked mode after all power cycle events.

ALARM CODE TABLES

Alarm Index Table Codes		
Alarm Index	Description	Binary Codes
0	No Alarm	
1	High Level Alarm	0b0000000000000000X
2	Low Level Alarm	0b0000000000000000X0
3	Future	
4	Pump 1 Bearing Alarm	0b0000000000000X000
5	Pump 2 Bearing Alarm	0b0000000000000X0000
6	Lead Bearing Fault	0b00000000000X00000
7	Lead Amp Pump Fault	0b000000000X000000
8	Future	
9	Future	
10	Future	

Trip Index Table Codes		
Trip Index	Description	Binary Codes
11	High Level Shutdown	0b00000X0000000000
12	Pump Amps Failure	0b0000X00000000000
13	Pump Bearing Failure	0b000X000000000000
14	VFD Fault	0b00X0000000000000
15	High Level Float	0b0X00000000000000
16	Future	

Alarm Index Table Codes will show the last Failure fully written out on System Data screen 12/12. The last code is also available via Modbus RTU in holding register 22.

The Binary Codes are the binary bit positions for each failure. Each bit position is set at the time

for each failure. All binary codes are also available via Modbus RTU in holding register 23.

I/O DESCRIPTIONS

DIGITAL OUTPUTS

I/O #	DESCRIPTION	TYPE
1	Pump VFD Run	OUTPUT
2	Vent Solenoid	OUTPUT
3	Future Output	OUTPUT
4	Pump 2 Select	OUTPUT
5	Alarm Output	OUTPUT
6	Future Output	OUTPUT
7	Future Output	OUTPUT
8	Future Output	OUTPUT
9	Future Output	OUTPUT
10	Future Output	OUTPUT

PUMP VFD RUN – When the Level Transfer is requested to start, this output is energized after the “Vent Solenoid Delay”. When the Level Transfer is requested to stop, this output is de-energized.

VENT SOLENOID – When the Level Transfer is requested to start, this output is energized. When the Level Transfer is requested to stop, this output is de-energized. After the “Vent Solenoid Delay”.

Output #3 – Future Output.

PUMP 2 SELECT – This input selects the current pump to control. When this output is de-energized pump 1 is selected. When this output is energized pump 2 is selected. Note that the associated pump pressure input and bearing monitor input is also selected.

Alarm Output – The Alarm Output is energized when in alarm or cutout. The Alarm Output is de-energized when there are no failures.

Output #6 – Future Output.

- Output #7** – Future Output.
- Output #8** – Future Output.
- Output #9** – Future Output.
- Output #10** – Future Output.

DIGITAL INPUTS

I/O #	DESCRIPTION	TYPE
1	High Level (Float) Shutdown NC contact	INPUT
2	VFD Not Ready NO contact	INPUT
3	Future	INPUT
4	Future	INPUT
5	Future	INPUT
6	Future	INPUT

Input #1 HIGH LEVEL SHUTDOWN – When this input is de-energized for 3 seconds a “High Level Float” Trip will occur.

Input #2 VFD NOT READY – When this input is energized for 3 seconds a “VFD Fault” Trip will occur.

Input #3 – Future input.

Input #4 – Future input.

Input #5 – Future input.

Input #6 – Future input.

ANALOG INPUTS

AI #	DESCRIPTION	TYPE
1	Vessel Level	4-20 mA
2	Vessel Pressure	4-20 mA
3	Pump 1 Pressure	4-20 mA
4	Pump 1 Bearing Monitor	4-20 mA
5	Pump Motor Current	4-20 mA
6	Pump 2 Pressure	4-20 mA
7	Pump 2 Bearing Monitor	4-20 mA
8	FUTURE	4-20 mA
9	FUTURE	4-20 mA
10	FUTURE	4-20 mA

VESSEL LEVEL – Measures the Vessel Level. The sensor is a 0 to 100 %, 4-20 mA input.

VESSEL PRESSURE – Measures the Vessel Pressure. The sensor is a 0 to 500 PSIG, 4-20 mA input.

PUMP 1 PRESSURE – Measures the Pump 1 Pressure. The sensor is a 0 to 500 PSIG, 4-20 mA input.

PUMP 1 BEARING MONITOR – Measures the Pump 1 Bearing Monitor, The sensor is a 0 - 1.00 4-20 mA input.

PUMP MOTOR CURRENT – Measures the Pump Motor Current. The sensor is a 0 – 17.5 amps 4-20 mA input.

PUMP 2 PRESSURE – Measures the Pump 2 Pressure. The sensor is a 0 to 500 PSIG, 4-20 mA input.

PUMP 2 BEARING MONITOR – Measures the Pump 2 Bearing Monitor, The sensor is a 0 - 1.00 4-20 mA input.

Input #8 – Future sensor input.

Input #9 – Future sensor input.

Input #10 – Future sensor input.

ANALOG OUTPUTS

AI #	DESCRIPTION	TYPE
1	Liquid Level Output (0 To 100 % = 4-20ma SIGNAL)	4-20 mA
2	Pump VFD Control Speed (0 To 100 % = 4-20ma SIGNAL)	4-20 mA
3	Future	4-20 mA
4	Future	4-20 mA
5	Future	4-20 mA
6	Future	4-20 mA

Liquid Level Output – This 4-20 mA output provides a remote 0 – 100% signal representing the current liquid level.

Pump VFD Control Speed – This 4-20 mA output is connected to a variable frequency drive (VFD) which controls the pump(s) VFD SPEED.

DISPLAY ASSEMBLY INTERFACE

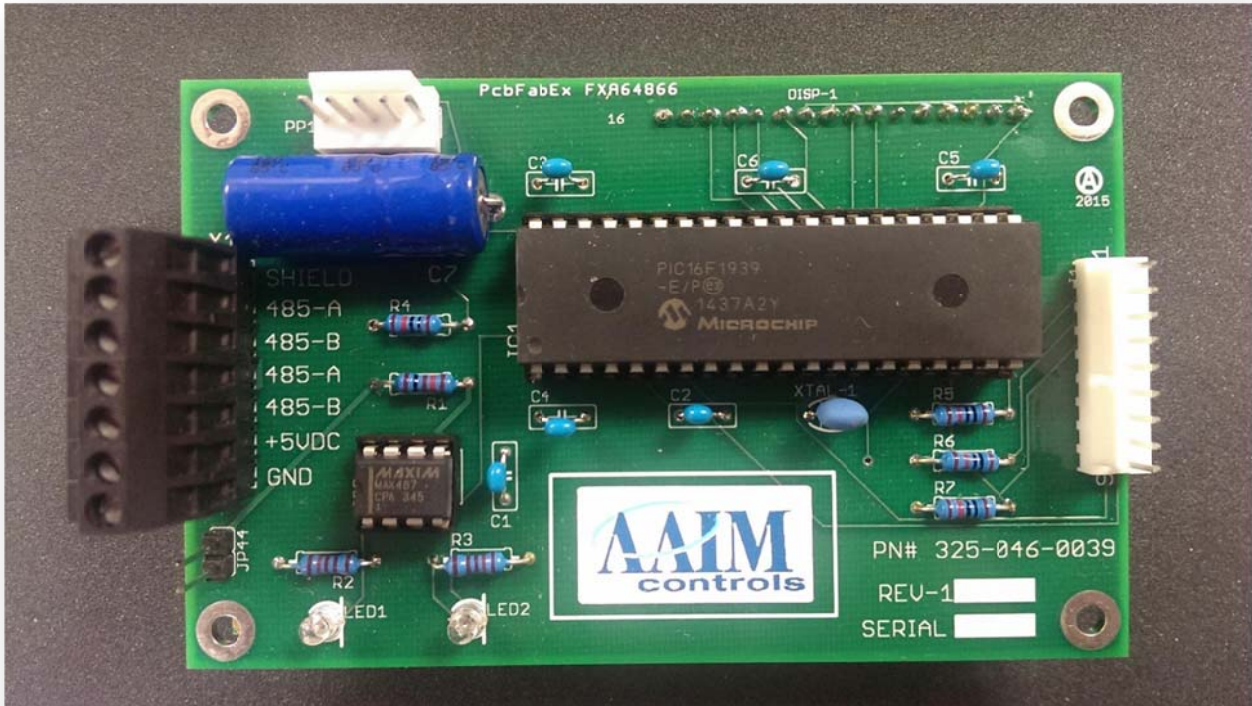

Display Assembly Interface - The display assembly interface acts as an HMI (Human Machine Interface) for the control panel. The microprocessor in this assembly scans the keypad for entry and displays the information on the OLED display screen. Information is passed from the display assembly interface to the main microprocessor controller on the I/O board.

DIGITAL I/O BOARD

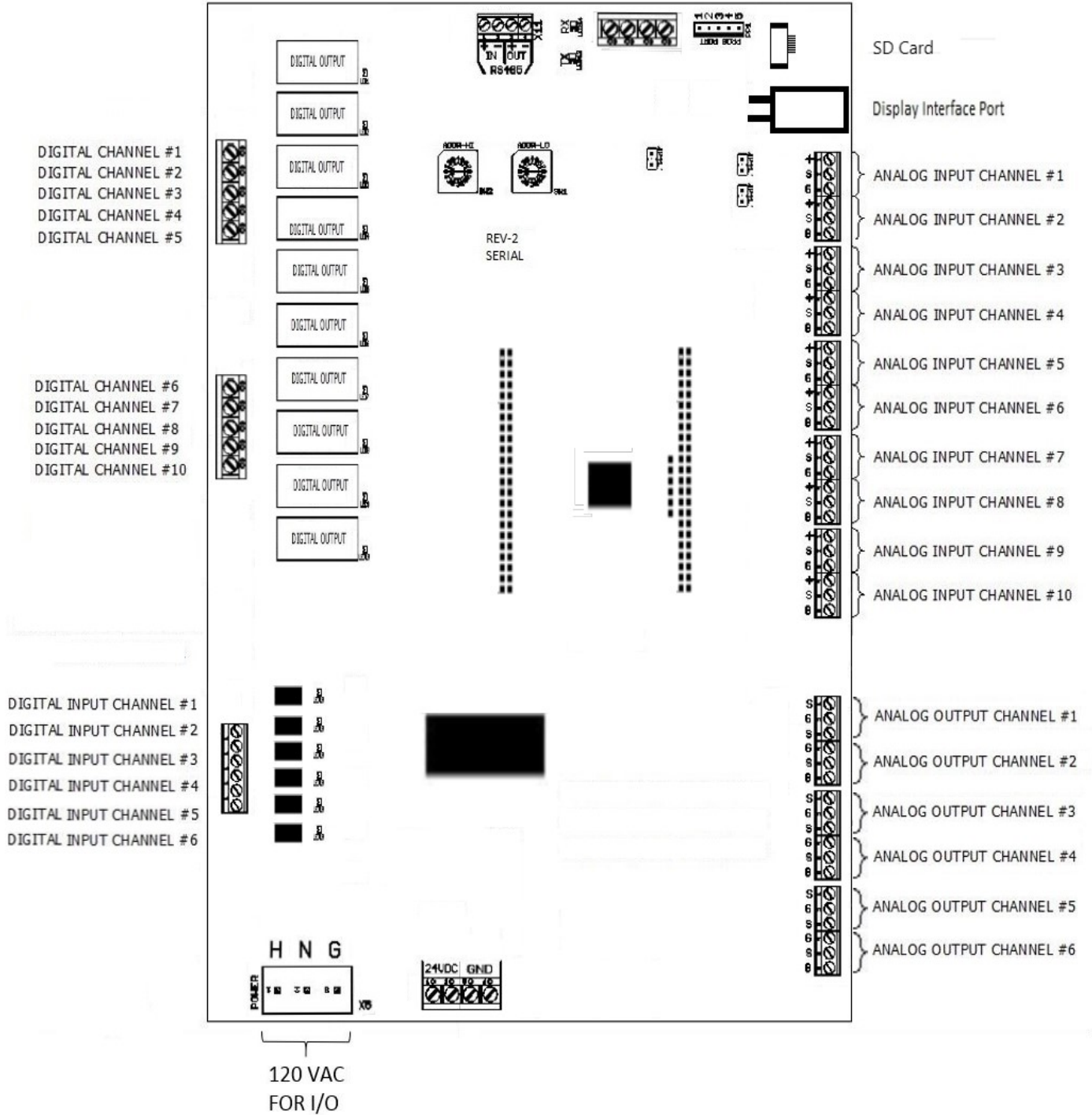

HARDWARE SPECIFICATIONS

INPUT POWER

- 88 – 125 VAC 47 – 63 Hz * Standard
- 185 – 264 VAC 47 – 63 Hz * Optional (Contact factory)

DC OUTPUT POWER

- 24 VDC 2.2A (52.8 Watts max)

ENVIRONMENTAL (CONTROLLER ONLY)

- Operating temperature -40°F to 140°F (-40°C to 60°C)
- Storage temperature -40°F to 158°F (-40°C to 70°C)
- Humidity 5% to 90% @ +40°C (non-condensing)
- Vibration 2.0g's (19.61m/s²)
- Shock 100g's (980m/s²)
- RFI Immunity 15v/m (15MHz to 1.5GHz)
- EMI Immunity Complies with CE EMC directive

ENVIRONMENTAL (CONTROLLER INTEGRATED WITH POWER ELECTRONICS)

- Operating temperature (w/o heater) 32°F to 140°F (0°C to 60°C)
- Low Temp operation Panel heat option required:
(-20°F / -29°C minimum ambient)
- Storage temperature -40°F to 158°F (-20°C to 70°C)
- Humidity 5% to 90% @ +40°C (non-condensing)
- Vibration 2.0g's (19.61m/s²)
- Shock 100g's (980m/s²)
- RFI Immunity 15v/m (15MHz to 1.5GHz)
- EMI Immunity Complies with CE EMC directive

DISPLAY

- Size 2.76" W x 0.825" H (70.16 mm x 20.95 mm)
- Character format 4 Lines x 20 Characters
- Type OLED
- Brightness 90 cd/m²

- Contrast Ratio 2,000:1
- Viewing Angle 80° from all angles
- Life > 100,000 Hours

KEYPAD / OVERLAY

- Material Polycarbonate with UV coating
- Keys Stainless Steel snap domes

CERTIFICATIONS

Agency approvals UL 508A, cUL

DIGITAL OUTPUTS

Type Relay
 Isolation 4 KV
 Continuous operating current 3 Amps maximum
 Peak 1-cycle surge current 100 Amps maximum
 Voltage 12 to 140 VAC
 Fusing 6 Amps
 Temperature rating -30°C to +80°C

DIGITAL INPUTS

Type Optically isolated
 Isolation 4 KV
 Voltage 90 TO 140 VAC
 Temperature rating -30°C to +80°C

ANALOG INPUTS

- Type 4-20 mA

ANALOG OUTPUTS

- Type 4-20 mA

TEMPERATURE SENSORS

-50°C to +200°C, 4-20mA output

Danfoss 084Z4114 MBT3560

PRESSURE SENSORS

0-200 PSIA, 4-20mA output

Danfoss 060G3807 AKS 3000

0-500 PSIG, 4-20 mA output

Danfoss 060G3807 AKS 3000

Material

100% stainless steel welded parts

Over pressure

2X Range

Burst pressure

5X Range

Technology

Signal-conditioned silicon strain gauge

Accuracy

+/- 0.5% of span

Excitation voltage

10 to 30 VDC

Temperature range

-40°F to +185°F (-40°C to +85°C)

MOTOR CURRENT SENSOR

Technology

4-20mA transmitter

EXTERNAL COMMUNICATIONS PORTS

RS-485 (Standard)

2.4K to 57.6K baud

Protocol

MODBUS RTU

COMMUNICATIONS ADDENDUM

Setpoints:

Modbus Address	Description	Min/Max	Default	Value	Read/Write	Additional
----------------	-------------	---------	---------	-------	------------	------------

						Info.
40001	Transfer Status	0 / 1	0	X 1	Read	
40002	Transfer Count	0 / 9999	0	X 1	Read	
40003	Transfer On Setpoint	0 / 100	70	X 1	Read / Write	
40004	Transfer Off Setpoint	0 / 100	60	X 1	Read / Write	
40005	Vent Solenoid Delay Setpoint	0 / 9	3	X 1	Read / Write	
40006	Liquid Transfer Mode Setpoint	0 / 2	0	X 1	Read / Write	0=Off, 1=Man, 2=Auto
40007	Select Lead Pump Setpoint	0 / 2	0	X 1	Read / Write	0=NA (1 Pump), 1=1 Pump, 2=2 Pumps
40008	High Level Shutdown Setpoint	0 / 100	90	X 1	Read / Write	
40009	High Level Shutdown Delay Setpoint	0 / 15	10	X 1	Read / Write	
40010	High Level Alarm Setpoint	0 / 100	80	X 1	Read / Write	
40011	High Level Alarm Delay Setpoint	0 / 15	5	X 1	Read / Write	
40012	Low Level Alarm Setpoint	0 / 100	10	X 1	Read / Write	
40013	Low Level Alarm Delay Setpoint	0 / 30	15	X 1	Read / Write	
40014	Low Motor Amps Alarm Setpoint	0 / 300	1	X 10	Read / Write	1=1.0 Amps
40015	Low Motor Amps Alarm Delay Setpoint	0 / 60	10	X 1	Read / Write	
40016	Low Motor Amps Inhibit Setpoint	0 / 300	60	X 1	Read / Write	
40017	Cavitation Pressure Setpoint	0 / 50	20	X 1	Read / Write	
40018	Cavitation Delay Setpoint	0 / 300	60	X 1	Read / Write	
40019	Cavitation Inhibit Setpoint	0 / 300	60	X 1	Read / Write	

Configuration Settings:

Modbus Address	Description	Min / Max	Default	Value	Read/Write	Additional Info.
40020	Number Of Pumps	1 / 2	1	X 1	Read / Write	1 = 1 Pump, 2 = 2 Pumps

System Status:

Modbus Address	Description	Value	Read/Write
40021	System Run Status	0=off disabled, 1=enabled Auto, 2=enabled Auto On	Read
40022	Alarm Code	Last failure code. See Alarm Index Table.	Read
40023	Alarm Binary Codes	0-65535 (0xFFFF). See Alarm Binary Table.	Read
40024	Current Board Temp.	Degrees F 0 to 257 (X 1)	Read
40025	Board Heater Status	0=Off, 1=On (On if temp is <=32F, Off if temp >=34F)	Read
40026	Program Version	Version (X 100) eg. 90 is version .90	Read

Digital Outputs:

Modbus Address	Description	Location	Type	Value	Read/Write
40027	Pump VFD Run	Digital 1	Output	0=off, 1=on	Read
40028	Vent Solenoid	Digital 2	Output	0=off, 1=on	Read
40029	Unused Output #3	Digital 3	Output	0=off, 1=on	Read
40030	Pump #2 Select	Digital 4	Output	0=off, 1=on	Read
40031	Alarm Output	Digital 5	Output	0=off, 1=on	Read
40032	Unused Output #6	Digital 6	Output	0=off, 1=on	Read
40033	Unused Output #7	Digital 7	Output	0=off, 1=on	Read
40034	Unused Output #8	Digital 8	Output	0=off, 1=on	Read
40035	Unused Output #9	Digital 9	Output	0=off, 1=on	Read
40036	Unused Output #10	Digital 10	Output	0=off, 1=on	Read

Digital Inputs:

Modbus Address	Description	Location	Type	Value	Read/Write
40037	High Level Shutdown	Digital Input 1	Input	0=off, 1=on	Read
40038	VFD Not Ready	Digital Input 2	Input	0=off, 1=on	Read
40039	Unused Input #3	Digital Input 3	Input	0=off, 1=on	Read
40040	Unused Input #4	Digital Input 4	Input	0=off, 1=on	Read
40041	Unused Input #5	Digital Input 5	Input	0=off, 1=on	Read
40042	Unused Input #6	Digital Input 6	Input	0=off, 1=on	Read

Analog Inputs:

Modbus Address	Description	Location	Type	Min / Max	Value	Read/Write
40043	Vessel Level	Analog 1	Input	0 – 100 %	X 10	Read
40044	Vessel Pressure	Analog 2	Input	0 – 500 PSIG	X 10	Read
40045	Pump 1 Pressure	Analog 3	Input	0 – 500 PSIG	X 10	Read

40046	Pump Bearing Monitor	Analog 4	Input	0 – 1.00	X 100	Read
40047	Pump Motor Current	Analog 5	Input	0 – 17.5 Amps	X 10	Read
40048	Pump 2 Pressure	Analog 6	Input	0 – 500 PSIG	X 10	Read
40049	Pump 2 Bearing Monitor	Analog 7	Input	0 – 1.00	X 100	Read
40050	Future	Analog 8	Input		X 10	Read
40051	Future	Analog 9	Input		X 10	Read
40052	Future	Analog 10	Input		X 10	Read

Analog Outputs Board 1:

Modbus Address	Description	Location	Type	Min / Max	Value	Read/Write
40053	Analog Output 1	Analog Out 1	Output	0 - 100 %	X 10	Read
40054	Analog Output 2	Analog Out 2	Output	0 - 100 %	X 10	Read
40055	Analog Output 3	Analog Out 3	Output	0 - 100 %	X 10	Read
40056	Analog Output 4	Analog Out 4	Output	0 - 100 %	X 10	Read
40057	Analog Output 5	Analog Out 5	Output	0 - 100 %	X 10	Read
40058	Analog Output 6	Analog Out 6	Output	0 - 100 %	X 10	Read

Analog Board 1 - Transducer Settings:

Modbus Address	Description	Min/Max	Default	Value	Read/Write
40059	BRD1 Input Chan 1 Signal Type	0 Only	0	X 1	Read
40060	BRD1 Input Chan 1 Low	-9999 To 9999	0	X 10	Read
40061	BRD1 Input Chan 1 High	-9999 To 9999	1000	X 10	Read
40062	BRD1 Input Chan 1 Offset	-9999 To 9999	0	X 10	Read
40063	BRD1 Input Chan 2 Signal Type	0 Only	0	X 1	Read
40064	BRD1 Input Chan 2 Low	-9999 To 9999	0	X 10	Read
40065	BRD1 Input Chan 2 High	-9999 To 9999	5000	X 10	Read
40066	BRD1 Input Chan 2 Offset	-9999 To 9999	0	X 10	Read
40067	BRD1 Input Chan 3 Signal Type	0 Only	0	X 1	Read
40068	BRD1 Input Chan 3 Low	-9999 To 9999	0	X 10	Read
40069	BRD1 Input Chan 3 High	-9999 To 9999	5000	X 10	Read
40070	BRD1 Input Chan 3 Offset	-9999 To 9999	0	X 10	Read
40071	BRD1 Input Chan 4 Signal Type	0 Only	0	X 1	Read
40072	BRD1 Input Chan 4 Low	-9999 To 9999	0	X 10	Read
40073	BRD1 Input Chan 4 High	-9999 To 9999	1000	X 10	Read
40074	BRD1 Input Chan 4 Offset	-9999 To 9999	0	X 10	Read
40075	BRD1 Input Chan 5 Signal Type	0 Only	0	X 1	Read
40076	BRD1 Input Chan 5 Low	-9999 To 9999	0	X 10	Read
40077	BRD1 Input Chan 5 High	-9999 To 9999	1750	X 10	Read
40078	BRD1 Input Chan 5 Offset	-9999 To 9999	0	X 10	Read
40079	BRD1 Input Chan 6 Signal Type	0 Only	0	X 1	Read
40080	BRD1 Input Chan 6 Low	-9999 To 9999	0	X 10	Read
40081	BRD1 Input Chan 6 High	-9999 To 9999	5000	X 10	Read
40082	BRD1 Input Chan 6 Offset	-9999 To 9999	0	X 10	Read

40083	BRD1 Input Chan 7 Signal Type	0 Only	0	X 1	Read
40084	BRD1 Input Chan 7 Low	-9999 To 9999	0	X 10	Read
40085	BRD1 Input Chan 7 High	-9999 To 9999	1000	X 10	Read
40086	BRD1 Input Chan 7 Offset	-9999 To 9999	0	X 10	Read
40087	BRD1 Input Chan 8 Signal Type	0 Only	0	X 1	Read
40088	BRD1 Input Chan 8 Low	-9999 To 9999	0	X 10	Read
40089	BRD1 Input Chan 8 High	-9999 To 9999	1000	X 10	Read
40090	BRD1 Input Chan 8 Offset	-9999 To 9999	0	X 10	Read
40091	BRD1 Input Chan 9 Signal Type	0 Only	0	X 1	Read
40092	BRD1 Input Chan 9 Low	-9999 To 9999	0	X 10	Read
40093	BRD1 Input Chan 9 High	-9999 To 9999	1000	X 10	Read
40094	BRD1 Input Chan 9 Offset	-9999 To 9999	0	X 10	Read
40095	BRD1 Input Chan 10 Signal Type	0 Only	0	X 1	Read
40096	BRD1 Input Chan 10 Low	-9999 To 9999	0	X 10	Read
40097	BRD1 Input Chan 10 High	-9999 To 9999	1000	X 10	Read
40098	BRD1 Input Chan 10 Offset	-9999 To 9999	0	X 10	Read

Analog - Outputs (Min and Max Count Limits):

Modbus Address	Description	Min/Max	Default	Value	Read/Write
40099	BRD1 Chan 1 Analog Output Max Bits Count	0 - 4095	3270	X 1	Read
40100	BRD1 Chan 1 Analog Output Min Bits Count	0 - 4095	650	X 1	Read
40101	BRD1 Chan 2 Analog Output Max Bits Count	0 - 4095	3270	X 1	Read
40102	BRD1 Chan 2 Analog Output Min Bits Count	0 - 4095	650	X 1	Read
40103	BRD1 Chan 3 Analog Output Max Bits Count	0 - 4095	3270	X 1	Read
40104	BRD1 Chan 3 Analog Output Min Bits Count	0 - 4095	650	X 1	Read
40105	BRD1 Chan 4 Analog Output Max Bits Count	0 - 4095	3270	X 1	Read
40106	BRD1 Chan 4 Analog Output Min Bits Count	0 - 4095	650	X 1	Read
40107	BRD1 Chan 5 Analog Output Max Bits Count	0 - 4095	3270	X 1	Read
40108	BRD1 Chan 5 Analog Output Min Bits Count	0 - 4095	650	X 1	Read
40109	BRD1 Chan 6 Analog Output Max Bits Count	0 - 4095	3270	X 1	Read
40110	BRD1 Chan 6 Analog Output Min Bits Count	0 - 4095	650	X 1	Read

Modbus Communications:

Modbus Address	Description	Min/Max	Default	Value	Read/Write
40111	Communications Good Packets Counter. X 1 (rolls over to 0 after 65535)	0 - 65535	0	X 1	Read
40112	Communications Bad Packets Counter. X 1 (rolls over to 0 after 65535)	0 - 65535	0	X 1	Read